

RAPIDSEAM TRIM

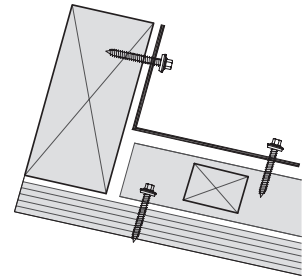

BOTTOM FLASH RSTMBTFLXX

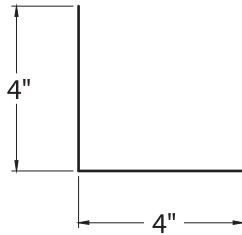
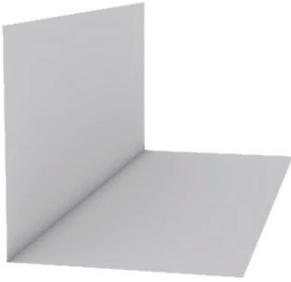

CLEAR STORY RSTMCLSTXX

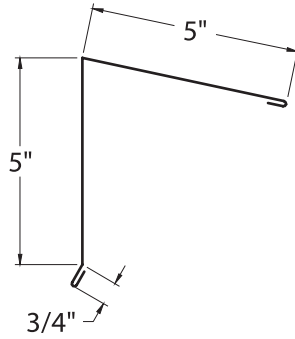

*Roof pitch required

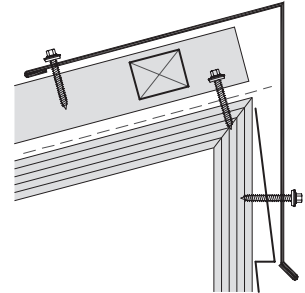

EAVE RSTMEAVEXX

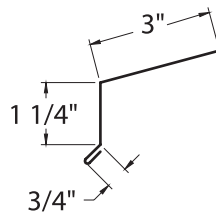

*Roof pitch required

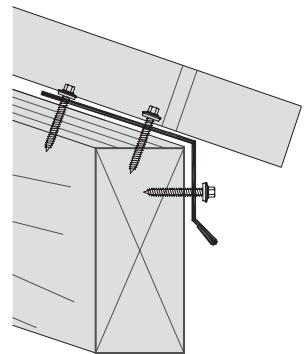

END WALL 2 RSTMENDWXX

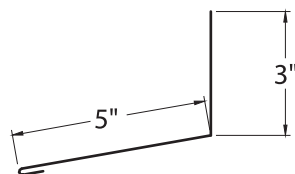
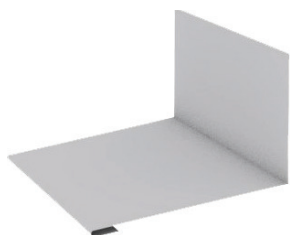

*Roof pitch required

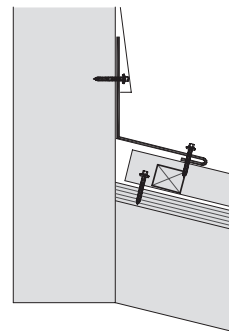

RAPIDSEAM TRIM



GABLE 1
RSTMGAB1XX

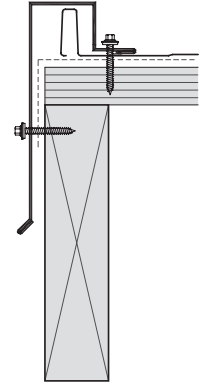
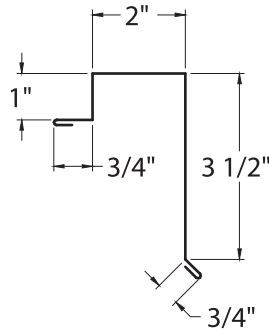

GABLE 2
RSTMGAB2XX

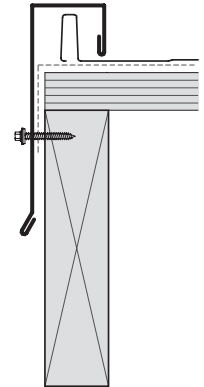
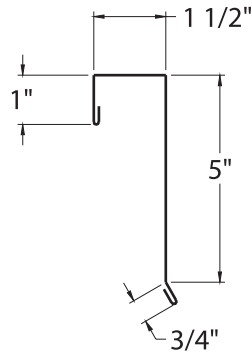

SWEPTWING GABLE
RSTMSWGBXX

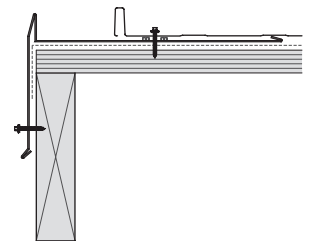
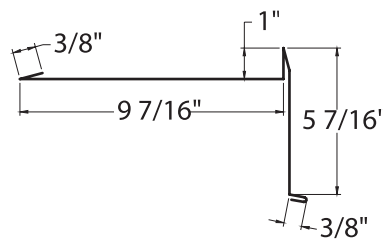
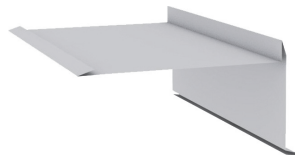

GAMBREL TRANSITION
RSTMGTANXX

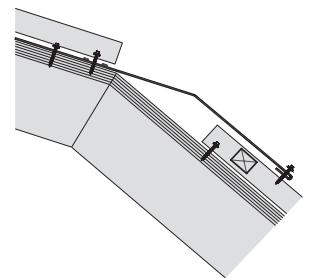
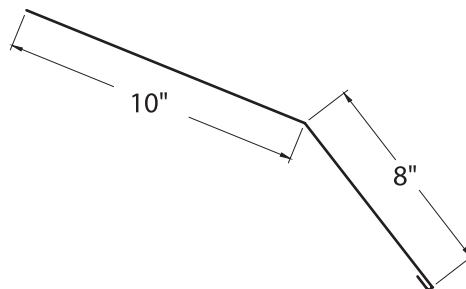

*Roof pitch required

RAPIDSEAM TRIM



HIP CAP
RSTMRHPCPXX

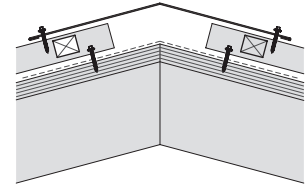
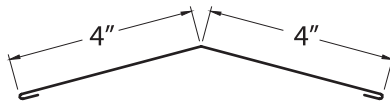

*Roof pitch required

RIDGE / HIP J FLASH
RSTMRHJFXX

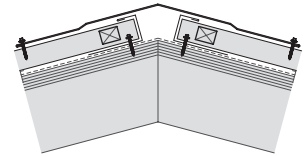
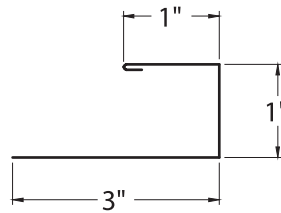
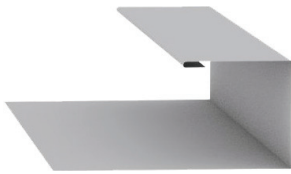

RIDGE CAP 1
RSTMRDC1XX

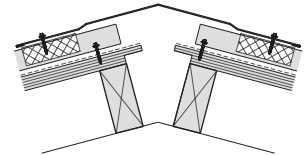
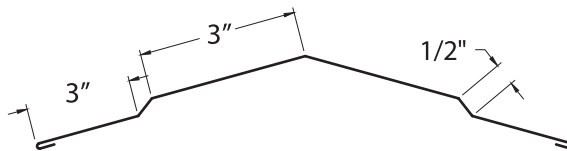

*Roof pitch required

RIDGE CAP 2
RSTMRDC2XX

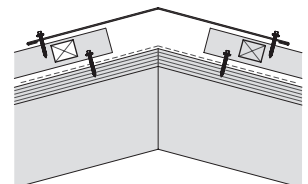
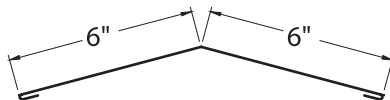

*Roof pitch required

RAPIDSEAM TRIM



SIDEWALL 1
RSTMSDW1XX

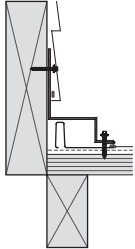
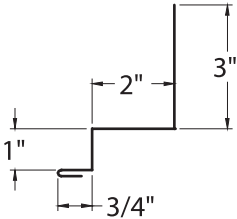
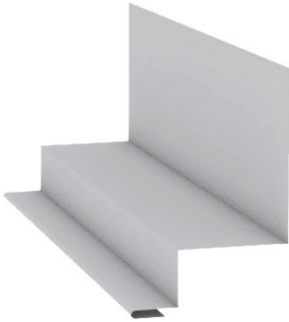

SIDEWALL 2
RSTMSDW2XX

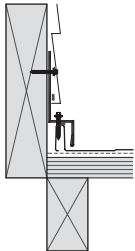
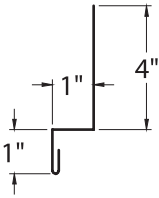

SKYLIGHT TOP
RSTMSKYTXX

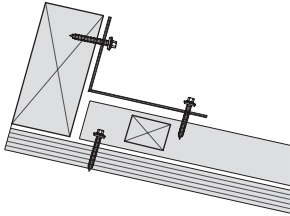
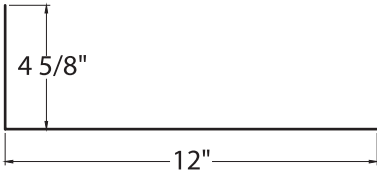
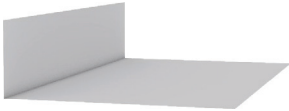

TRANSITION
RSTMTRFLXX

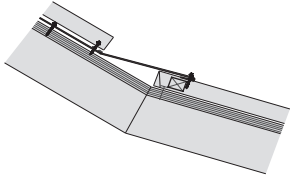
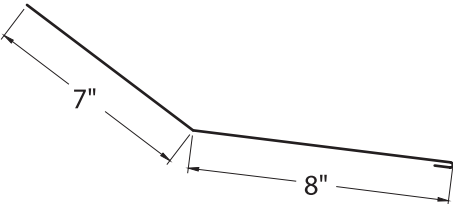
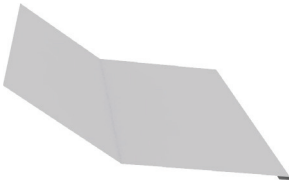

*Roof pitch required

RAPIDSEAM TRIM



STANDARD VALLEY
RSTMSTDVYXX

